

Specification of Thermoelectric Module

TEC1-06310

Performance Curves at $T_h=27\text{ }^\circ\text{C}$

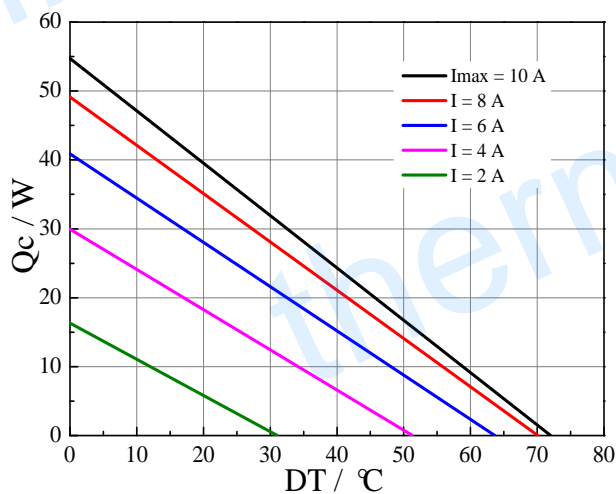

Performance Curves at $T_h=50\text{ }^\circ\text{C}$

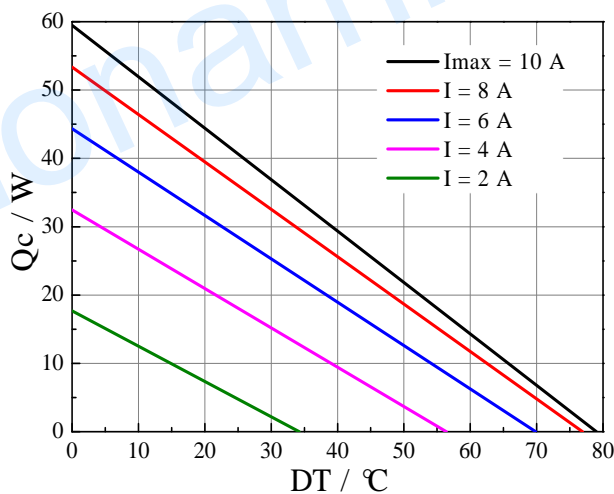

Standard Performance Graph $Q_c = f(DT)$

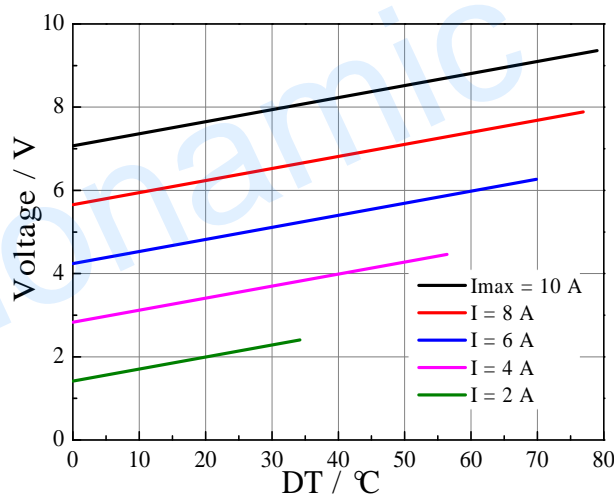
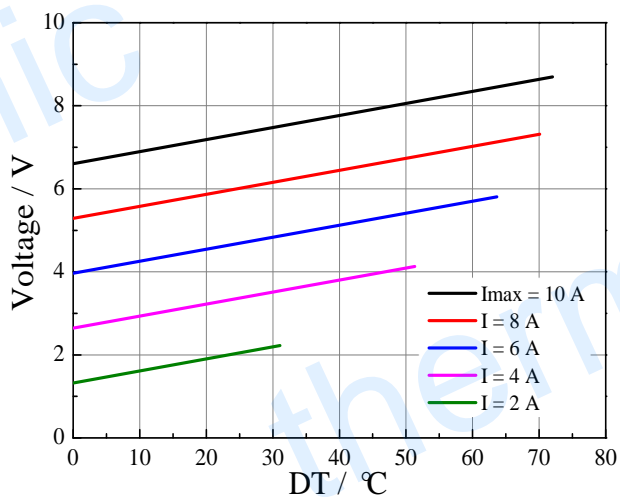

Standard Performance Graph $V = f(\Delta T)$

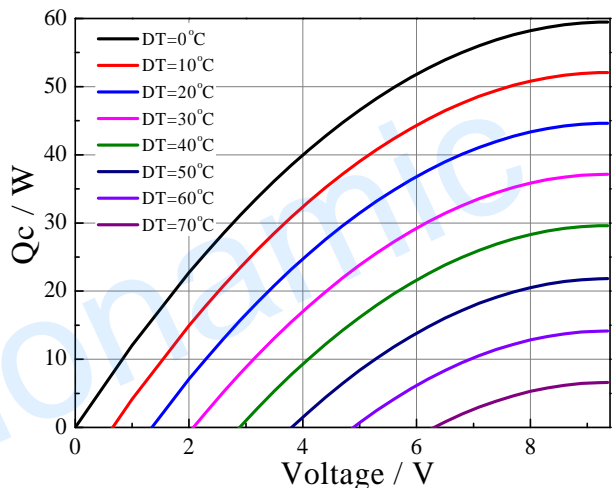
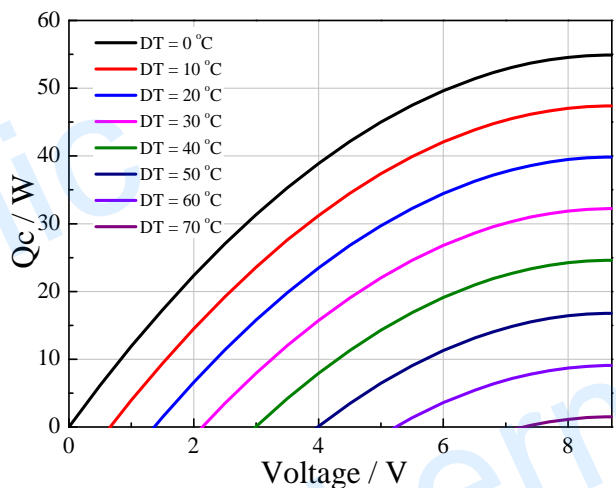

Standard Performance Graph $Q_c = f(V)$

Creative technology with fine manufacturing processes provides you the reliable and quality products

Tel: +86-791-88198288 Fax: +86-791-88198308 Email: sales@thermonamic.com.cn Web Site: www.thermonamic.com.cn

Specification of Thermoelectric Module

TEC1-06310

Performance Curves at Th=27 °C

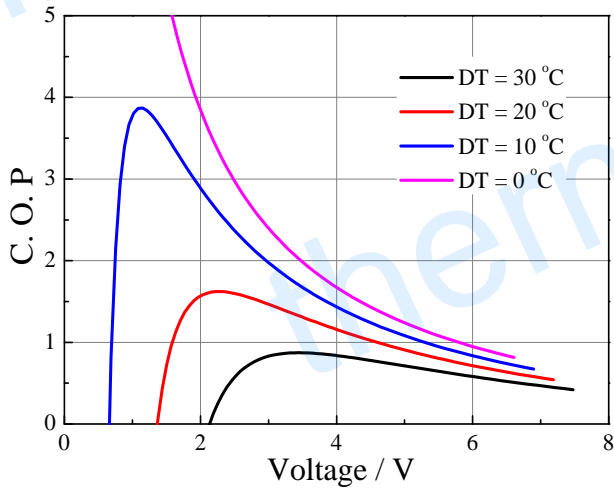

Performance Curves at Th=50 °C

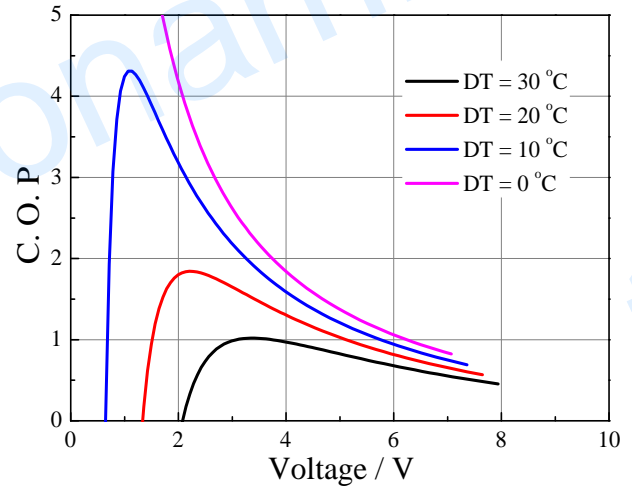

Standard Performance Graph COP = f(V) of ΔT ranged from 0 to 30 °C

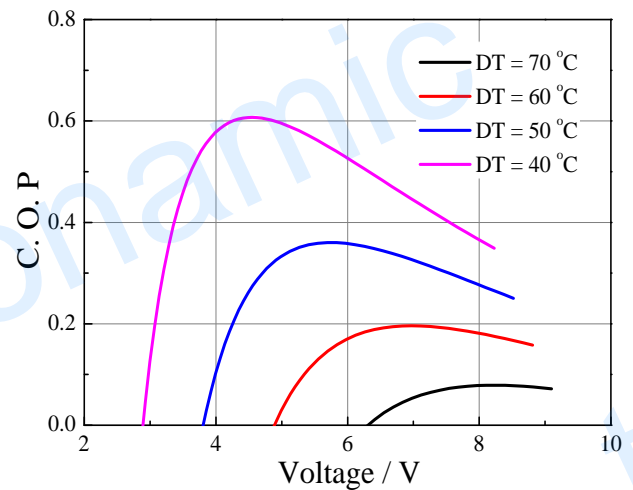
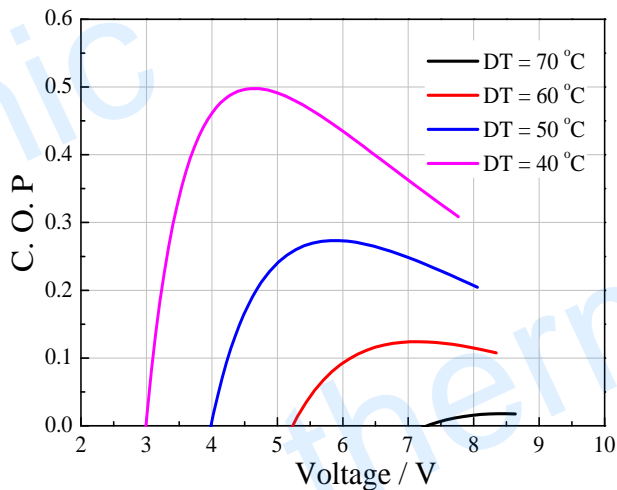

Standard Performance Graph COP = f(V) of ΔT ranged from 40 to 60/70 °C

Remark: The coefficient of performance (COP) is the cooling power Q_c /Input power ($V \times I$).

Operation Cautions

- Cold side of the module stuck on the object being cooled
- Hot side of the module mounted on a heat radiator
- Storage module below 100 °C
- Operation below I_{max} or V_{max}
- Work under DC